

MODELS-521, 522, 523, 524

Stainless steel case Brass internals Pressure Gauges

Dry, Liquid Fillable or Pre-Filled. VIBRAGAUGE® Option also available. VIBRAGAUGE® for Dampening of vibration & pulsation without liquid filling. With liquid-filled case for applications with high dynamic Pressure pulsations or vibration.

STANDARD SPECIFICATION

Gauge with Blow-out Device (Weatherproof Construction to IP66)

Sizes

63, 100 and 150 mm

Case/ Bezel

304 Stainless Steel (316 Stainless Steel can be supplied on request)

Socket & Element

Brass, Phosphor Bronze / Beryllium Copper

Movement

Brass

Blowout Protection

Blow-out plug at the top of the case

Dial

White Anodised Aluminium (Black Printing)

Pointer

Black Aluminium

Window

Sheet Glass

Traceability

All instruments are individually calibrated and have an unique Serial Number.

Certification available on request

- Certificate of Conformity Traceable to National Standards
- Group Certification (Pressure Test Calibration Statement)
- Point to Point Test Certificate

Safety

All units are manufactured to comply with EN 837-1, S1 Blowout device specification and other regulatory standards including PED 2014/68/EU.

Installation instructions

Refer to EN 837-2 and our [Guidance On Use of Equipment](#) data sheet.

Accuracy class

ACCURACY CLASS EN837-1 (Optional)			
	0 - 600 bar	>600 - 1000 bar	
63mm	1.0		
100mm	1.0 (0.6)	1.0	
150mm	1.0 (0.6)	1.0	

0.5% Accuracy on request (Consult Sales)

Over-pressure

0 - 100 bar	>100 - 600 bar	>600 - 1000 bar	
1.25 x FSD	1.15 x FSD	1.10 x FSD	

Scale Range

Vacuum / Compound to -1 to 0 to -1 to 24 bar
63mm gauge 0 to 600 bar
100 & 150mm gauges 0 to 1000 bar
Or other equivalent units of pressure or vacuum
PED 2014/68/EU, GAS Group.1 <1000 bar,

Pressure Connection Thread

1/8", 1/4", 3/8", 1/2" NPT, BSP, BSPT

MAX PRESSURE EN 837-1			
THREAD EN837	NPT (Brass)	BSP (Brass)	BSPT (Brass)
1/8"	400 bar	400 bar	400 bar
1/4"	600 bar	600 bar	600 bar
3/8"	600 bar	600 bar	600 bar
1/2"	600 bar	1000 bar	600 bar

Ordering Parameters, Please state the following: SIZE, MODEL NO, SCALE RANGE, CONNECTION, PRESSURE MEDIUM & OPTIONAL EXTRAS

Model-522 Direct Mounted



Model-521 Surface Mounted (Bottom Connection)
Model-522 Direct Mounted (Bottom Connection)
Model-523 Flush Mounted Screw Fixing (Rear Connection)
Model-524 Flush Mounted Clamp Fixing (Rear Connection)
[See Page-2 for dimension](#)

Operating Temperature Range EN837

-20° to 60°C (-4°F to 140°F)

[Options for lower/higher operating ranges \(Contact Sales\)](#)

Temperature Error

Additional error when temperature changes from reference
Temperature of 20°C (68°F) ±0.4% for every 10°C (18°F) rising or Falling % of span

Optional Extras

- Micro adjustable pointer /Black finish
- Optional dial materials & Custom markings
- Other pressure connections
- Laminated safety glass / Perspex window
- Orifice Restrictor Screw (standard Ø0.9mm, Ø0.4mm on request)
- Customer logo printed on dial
- Liquid filled / Suitable for liquid filling
- Nitelitegauge® (See data sheet)
- Vibragauge® (See data sheet)
- Fitted with electrical contacts (See data sheet)
- Gauge over-pressure up to 130% of FSD

[Further options on request](#)

Available with a wide range of accessories

Syphons, Snubbers, Overrange gauge protectors, Valves, Manifolds, Diaphragm seals, Swivel adaptors, etc ensures that STEWARTS can provide you with the right product to suit any individual application or requirement.

MODELS-521, 522, 523, 524

Stainless steel case Brass internals Pressure Gauges

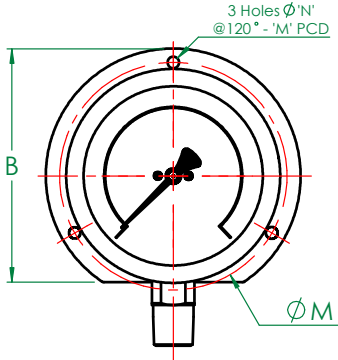

MODEL - 521
Surface Mounted

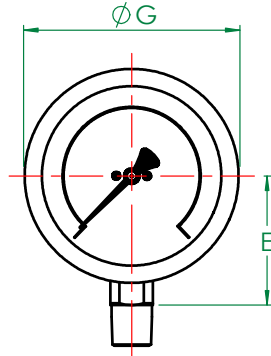
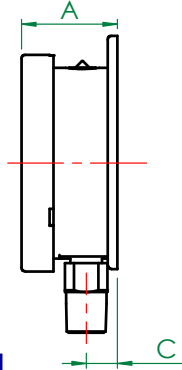

MODEL - 522
Direct Mounted (Standard)

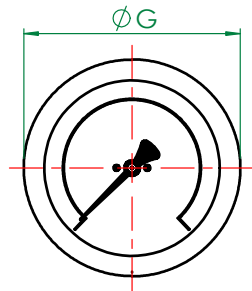
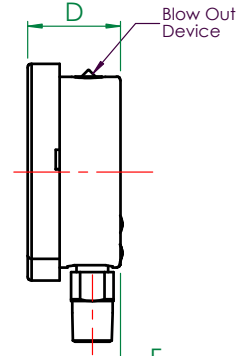

MODEL - 522-BC
Direct Mounted - Rear Connect

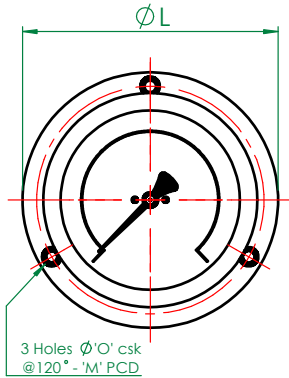
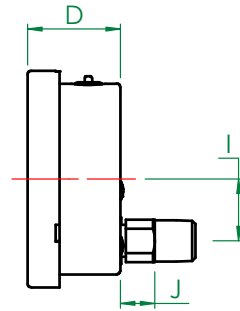

MODEL - 523
Flush Mounted - Screw Fixing

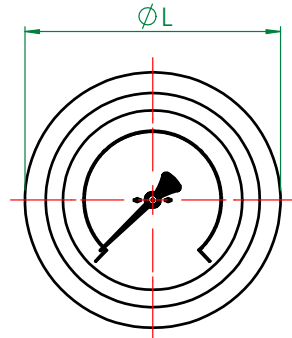
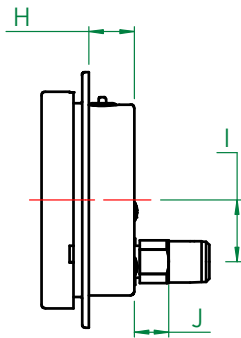

MODEL - 524
Flush Mounted - Clamp Fixing

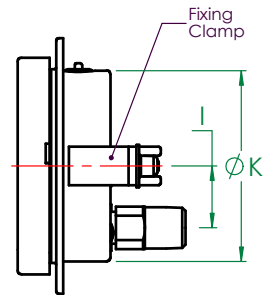

General Arrangement Dimensions in mm, tol' ± 1mm

DIM ø mm	A	B	C	D	E	F	G	H	I	J	K	L	M	N	O	CUT OUT
63 (2½")	34.5	78.5	12.5	31.5	41.8	9.5	68.4	21.5	18	13	62	85.2	75	3.5	3.8	66
100 (4")	50.7	121	16.2	49	66.9	14.5	112.2	24.5	32	18	99	132.5	118	6	6	106
150 (6")	52.7	174	18.4	49.5	92.1	15.2	161.7	24	32	17.8	148	186	168	5.8	5.8	153

STEWART-BUCHANAN GAUGES LTD

Sales Office & Manufacturing Facility - 7 Garrell Road, Burnside Industrial Estate, Kilsyth, Glasgow G65 9JX, SCOTLAND
Tel: +44 (0)1236 821533 | Fax: +44 (0)1236 824090 | E-mail: sales@stewarts-group.com | Web: stewarts-group.com

